

# Supermarket Series



**Nenwell**

Nenwell Refrigeration Technology Co., Ltd.  
Foshan Nenwell Import & Export Trading Co., Ltd.

Total Solution of Commercial Refrigerators Tel: 0086-757-85856069 Web: <http://www.nenwell.com/>  
Address: Rm 601, Bld# 5A Tianan Mansion, Jianping Rd, Guicheng, Nanhai, Foshan, Guangdong, China





## Your Ideal One-Stop Supplier of Commercial Fridges

Nenwell, China tier 1 commercial refrigeration solution provider, with 7+ affiliated factories standing behind us, we are enduring in operating mass production and fast delivery for valued clients across the world. Alongside the decades since China's open policy in 90's, Nenwell took deep root in China commercial refrigeration industry and grew into a total solution provider of commercial refrigeration equipment, such as reach in refrigerator, glass door merchandiser, countertop fridge, back bar fridge, conventional fridges and freezers, and medical purpose refrigerators. Besides these commercial refrigerators, also we are supplying numerous components and fridge production lines. Nenwell Import and Export is our export outlet and the helper in pivoting global supply chain in this field across the world. We are committed to become your ideal one-stop supplier of freezers and coolers.



## Nenwell, a Joint of High Quality upon Cost-Efficiency

Deeply rooted in China refrigeration industry for the past three decades, we have developed prominent expertise and leading technology which bring our manufacturing to world-class high quality. Quality and safety standards such as ISO90001, CE, RoHS, REACH, ETL, UL, NSF, CB, SAA and other norms are well met for different product lines. High quality products and efficient inner cost control empowers Nenwell to grow rapidly in the refrigeration field. Your one-stop refrigeration supplier is us as we run comprehensively full field refrigeration equipment, from cooler to freezer, from mini to large, from counter-top to free-standing, from complete units to components, and from products to production lines. We are professional in satisfying your OEM/ ODM and customized orders.

## We help Boost Your Brand in Catering and Retailing



We are always one step ahead of the food service and retailing business. Our insights in stylish designs, illuminated visibility, energy saving technology can definitely boost your brand distribution and retailing sales. Remarkable acknowledgements are bestowed to Nenwell through trustworthy cooperations with famous clients home and abroad, such as Qingdao Beer, Tiger Beer, Polar Bear, Nestle', Meiji, Dairy Queen, Arum, Klondike, Cream Bell, Dairy Day, Igloo, Orchard Fresh, Cold Stone, Llaollao, Fruits, Amorino, Galadari and the list extends yearly.





**Barrel Cooler**



**Countertop Chiller**



**Silm Upright Freezer**



**Upright Fridge**



**Cake Showcase**



**Ice Cream Showcase**



**Supermarket Merchandiser**



**Medical Refrigerator**

2 ~ 8°C Pharmacy Refrigerator



4°C Blood Bank Refrigerator



-40°C Biomedical Freezer



Transport Cooler

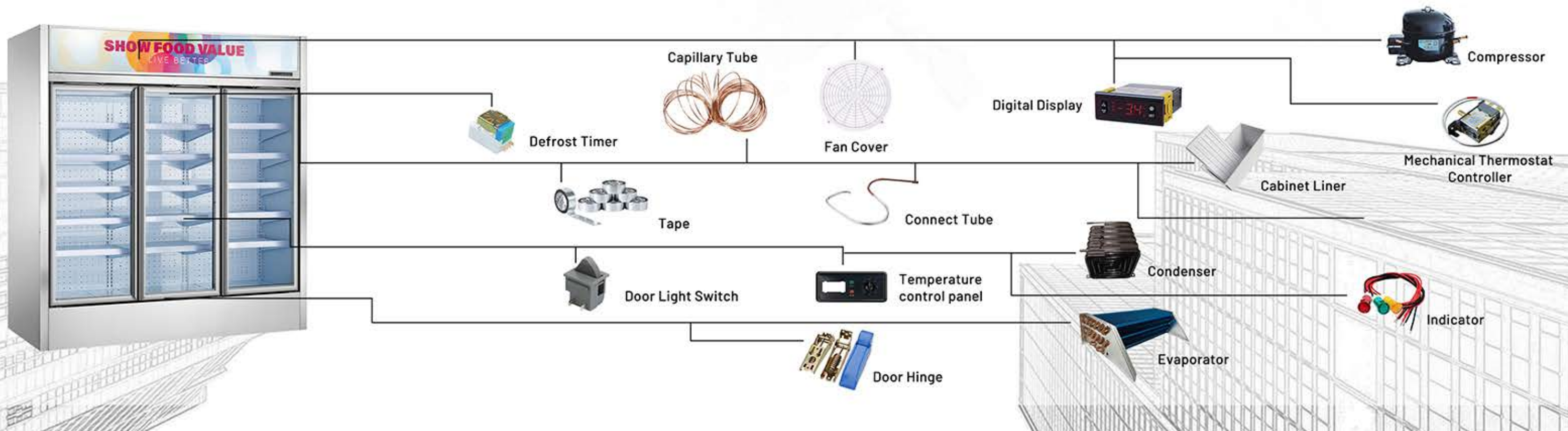



# CONTENTS

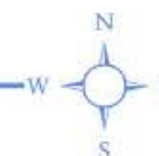

— Supermarket Series

Multideck Display Fridge		/01-14
Mini Ring Cabinet		/15-16
Dual-Temp Multi-Deck Cabinet		/17-18
Deli Display Fridge		/19-22
Meat Display Fridge		/23-24
Stainless Steel Fish Counter		/25-26
Combined Island Freezer		/27-28
Island & Twins Island Display Freezer		/29-32
Display Fridge & Freezer with Storage Room		/33-34

# Multideck Display Fridge











• A Series



## Features

- Refrigerant: R22 / R404a
- Panasonic / Copeland compressor
- Ventilated cooling system
- Open air curtain design with night curtain
- Double layer tempered glass
- Digital controller
- Four adjustable shelves with price tag bar
- Copper evaporator
- LED light for every shelf
- Drain water box
- Stainless steel inner

## Details Presentation

	 <p>Adjustable Shelves</p>		 <p>Night Soft Curtain</p>
	 <p>Heavy Duty Use</p>		 <p>Air Curtain System</p>
	 <p>digital temperature controller</p>		 <p>Excellent Thermal Insulation</p>
	 <p>Bright LED Lighting</p>		 <p>Outstanding Refrigeration</p>



NW-HG12A Plug-in Model



NW-HG20AF Remote Model



Model No	Product Size(mm)	Temp. Range(°C)	Cooling System	Shelf	Compressor	Remarks
NW-HG12A	1200*700*2000	2~8	Ventilated	5	Panasonic	Plug-in
NW-HG15A	1500*850*2000	2~8	Ventilated	5	Panasonic	Plug-in
NW-HG20A	2000*850*2000	2~8	Ventilated	5	Panasonic	Plug-in
NW-HG25A	2500*850*2000	2~8	Ventilated	5	Panasonic	Plug-in
NW-HG30A	3000*850*2000	2~8	Ventilated	5	Panasonic	Plug-in
NW-HG15AF	1500*1000*2000	2~8	Ventilated	5	Copeland	Remote
NW-HG20AF	2000*1000*2000	2~8	Ventilated	5	Copeland	Remote
NW-HG25AF	2500*1000*2000	2~8	Ventilated	5	Copeland	Remote
NW-HG30AF	3000*1000*2000	2~8	Ventilated	5	Copeland	Remote

# Multideck Display Fridge

· B Series

## Features

- Refrigerant: R22 / R404a
- Panasonic / Copeland compressor
- Ventilated cooling system
- Open air curtain design with night curtain
- Double layer tempered glass
- Digital controller
- Four adjustable shelves with price tag bar
- Copper evaporator
- LED light for every shelf
- Drain water box
- Stainless steel inner

## Details Presentation

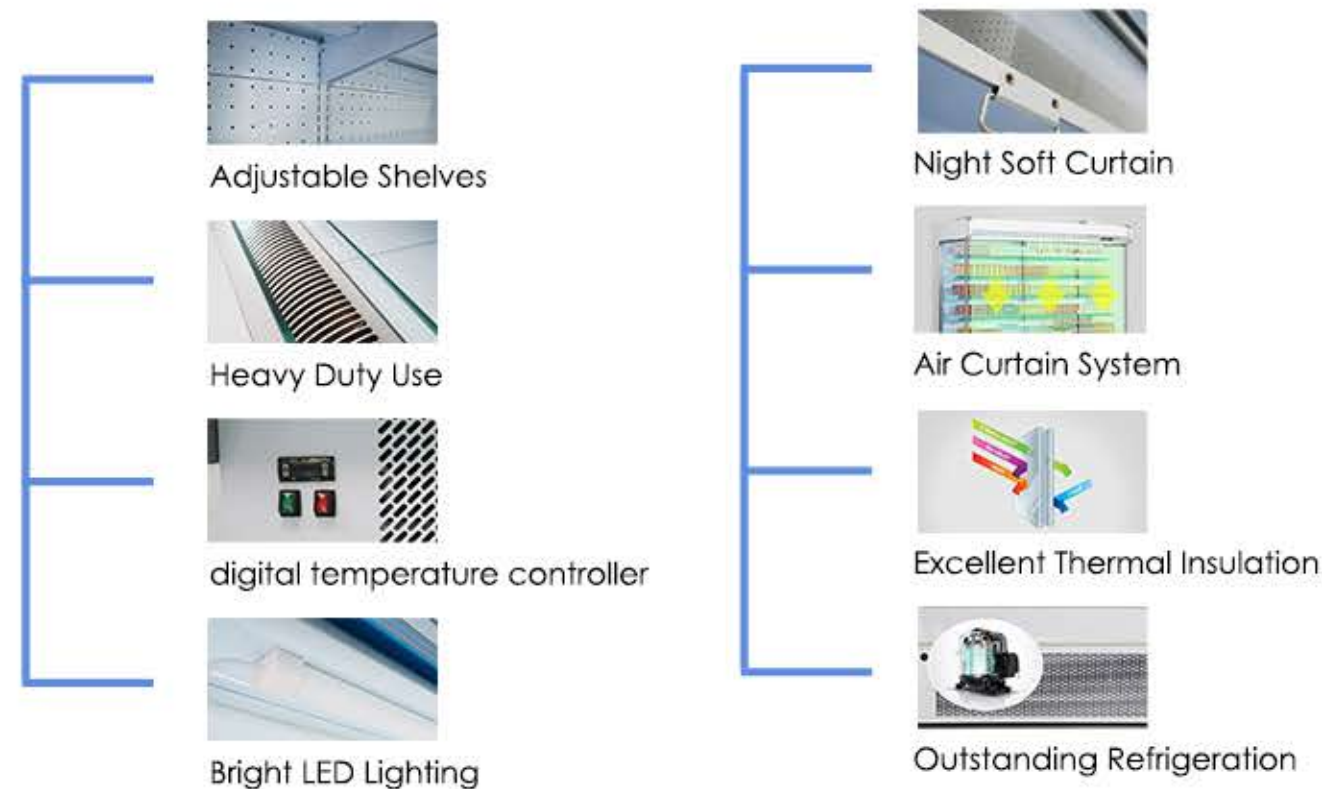



NW-HG12B Plug-in Model



NW-HG30BF Remote Model



Model No	Product Size(mm)	Temp. Range(°C)	Cooling System	Shelf	Compressor	Remarks
NW-HG12B	1200*700*2000	2~8	Ventilated	4	Panasonic	Plug-in
NW-HG15B	1500*850*2000	2~8	Ventilated	4	Panasonic	Plug-in
NW-HG20B	2000*850*2000	2~8	Ventilated	4	Panasonic	Plug-in
NW-HG25B	2500*850*2000	2~8	Ventilated	4	Panasonic	Plug-in
NW-HG30B	3000*850*2000	2~8	Ventilated	4	Panasonic	Plug-in
NW-HG15BF	1500*1000*2000	2~8	Ventilated	4	Copeland	Remote
NW-HG20BF	2000*1000*2000	2~8	Ventilated	4	Copeland	Remote
NW-HG25BF	2500*1000*2000	2~8	Ventilated	4	Copeland	Remote
NW-HG30BF	3000*1000*2000	2~8	Ventilated	4	Copeland	Remote



# Multideck Display Fridge

- C Series

## Features

- Refrigerant: R22 / R404a
- Panasonic / Copeland Compressor
- Ventilated cooling system
- Open air curtain design with night curtain
- Fiber glass side cover with double layers tempered glass
- Digital controller
- Four adjustable shelves with price tag bar
- Copper evaporator
- LED light for every shelf
- Drain water box
- Stainless steel inner

## Details Presentation

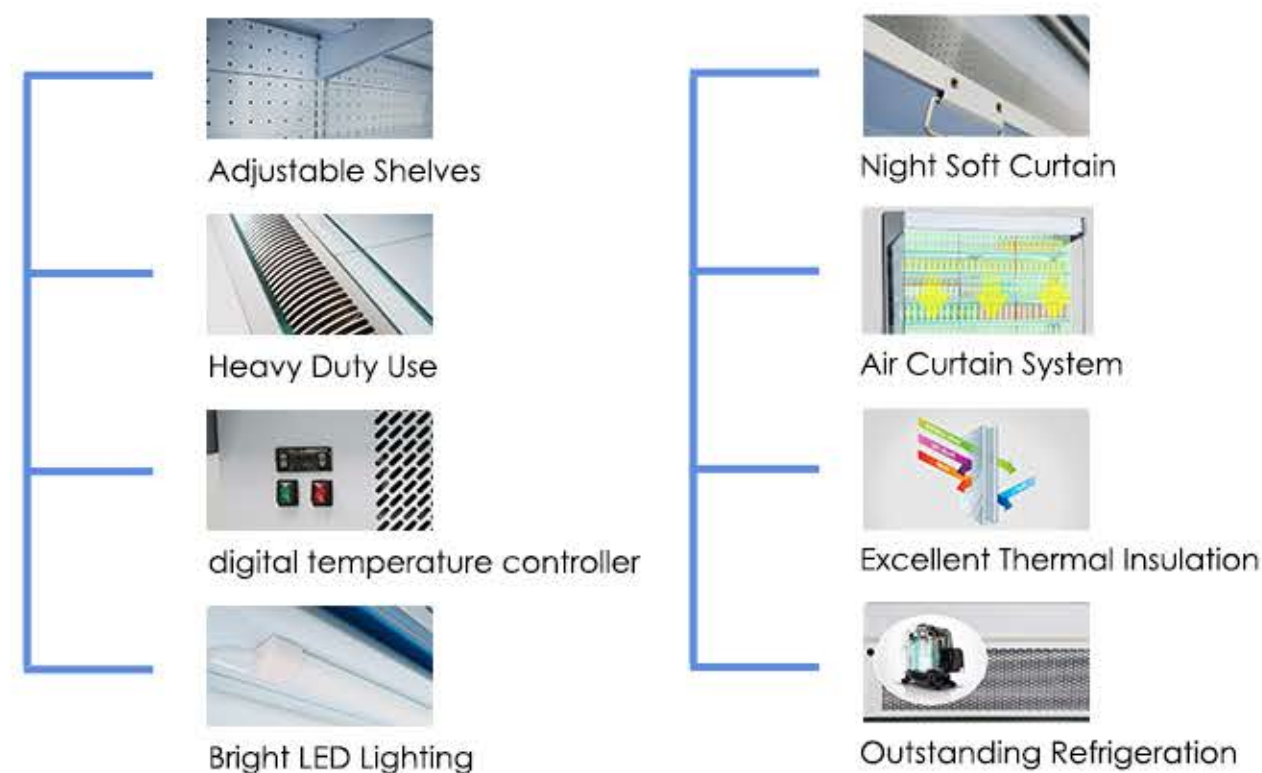





Model No	Product Size(mm)	Temp. Range(°C)	Cooling System	Shelf	Compressor	Remarks
NW-HG12C	1500*960*2050	2~8	Ventilated	4	Panasonic	Plug-in
NW-HG15C	2000*960*2050	2~8	Ventilated	4	Panasonic	Plug-in
NW-HG20C	2500*960*2050	2~8	Ventilated	4	Panasonic	Plug-in
NW-HG25C	2500*850*2000	2~8	Ventilated	4	Panasonic	Plug-in
NW-HG30C	3000*960*2050	2~8	Ventilated	4	Panasonic	Plug-in



# Multideck Display Fridge

- Luxury Series











## Features

- Refrigerant: R404a
- Digital controller
- Copper evaporator
- Thermostatic expansion valve
- Automatic defrost
- LED light for every shelf
- With tempered door
- Adjustable shelves
- With price lable setting
- Automatic drain water

## Options

- Customizable color for parts
- Thickness and material of the steel
- LED light or ordinary light
- with plexiglass door
- Side wall material
- Single tempered glass door

## Details Presentation

	 <p>Adjustable Shelves</p>		 <p>Night Soft Curtain</p>
	 <p>Heavy Duty Use</p>		 <p>Air Curtain System</p>
	 <p>digital temperature controller</p>		 <p>Excellent Thermal Insulation</p>
	 <p>Bright LED Lighting</p>		 <p>Outstanding Refrigeration</p>



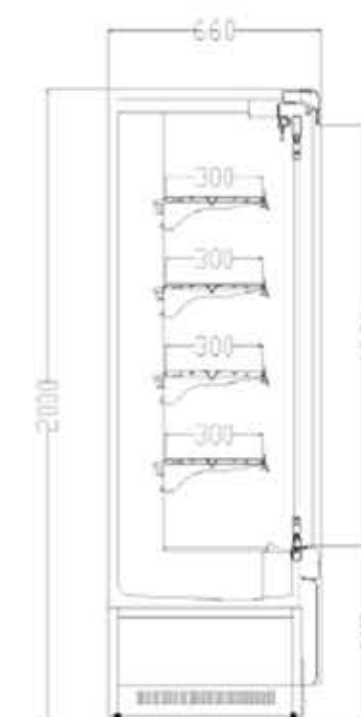
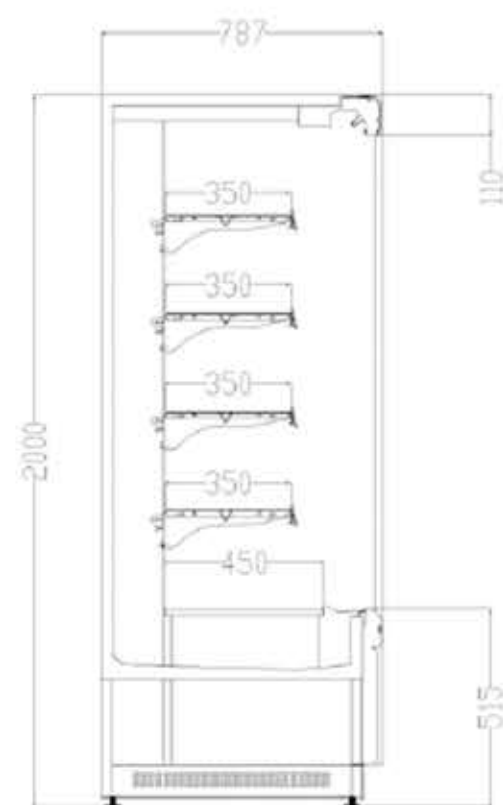

Model No	Product Size(mm)	Temp. Range(°C)	Cooling System	Shelf	Compressor	Remarks
NW-BLF780	700*780*2000	-1~7	Ventilated	4	Embraco	Plug-in
NW-BLF1080	997*787*2000	-1~7	Ventilated	4	Embraco	Plug-in
NW-BLF1380	1310*787*2000	-1~7	Ventilated	4	Embraco	Plug-in
NW-BLF1580	1500*787*2000	-1~7	Ventilated	4	Embraco	Plug-in
NW-BLF2080	1935*787*2000	-1~7	Ventilated	4	Embraco	Plug-in



# Multideck Display Fridge

- Hinge Glass Door

## Features

- Refrigerant: R22 / R404a
- Panasonic / Copeland Compressor
- Ventilated cooling system
- Low-E glass with heater
- Double layer tempered glass
- Digital controller
- Adjustable Shelves with price tag bar
- Copper evaporator
- LED light for every shelf
- Drain water box
- Stainless steel inner

NW-HG12M



NW-HG12MF





# • Product Parameters

Model No	Product Size(mm)	Temp. Range(°C)	Cooling System	Shelf	Compressor	Remarks
NW-HG12M	1200*850*2000	0~10 / -18 ~ -22	Ventilated	4	Panasonic	Plug-in
NW-HG15M	1500*850*2000	0~10 / -18 ~ -22	Ventilated	4	Panasonic	Plug-in
NW-HG20M	2000*850*2000	0~10 / -18 ~ -22	Ventilated	4	Panasonic	Plug-in
NW-HG25M	2500*850*2000	0~10 / -18 ~ -22	Ventilated	4	Panasonic	Plug-in
NW-HG30M	3000*850*2000	0~10 / -18 ~ -22	Ventilated	4	Panasonic	Plug-in
NW-HG12MF	1200*1000*2000	0~10 / -18 ~ -22	Ventilated	4	Copeland	Remote
NW-HG15MF	1500*1000*2000	0~10 / -18 ~ -22	Ventilated	4	Copeland	Remote
NW-HG20MF	2000*1000*2000	0~10 / -18 ~ -22	Ventilated	4	Copeland	Remote
NW-HG25MF	2500*1000*2000	0~10 / -18 ~ -22	Ventilated	4	Copeland	Remote
NW-HG30MF	3000*1000*2000	0~10 / -18 ~ -22	Ventilated	4	Copeland	Remote



# Multideck Display Fridge

- Sliding Glass Door

## Features

- Refrigerant: R22 / R404a
- Panasonic compressor
- Ventilated cooling system
- Low-E glass with heater
- Double layer tempered glass
- Digital controller
- Adjustable Shelves with price tag bar
- Copper evaporator
- LED light for every shelf
- Drain water box
- Stainless steel inner

NW-HG20YM



NW-HW20YMF





# • Product Parameters

Model No	Product Size(mm)	Temp. Range(°C)	Cooling System	Shelf	Compressor	Remarks
NW-HG12YM	1200*850*2000	0~10	Ventilated	4	Panasonic	Plug-in
NW-HG15YM	1500*850*2000	0~10	Ventilated	4	Panasonic	Plug-in
NW-HG20YM	2000*850*2000	0~10	Ventilated	4	Panasonic	Plug-in
NW-HG25YM	2500*850*2000	0~10	Ventilated	4	Panasonic	Plug-in
NW-HG30YM	3000*850*2000	0~10	Ventilated	4	Panasonic	Plug-in
NW-HG12YMF	1200*1000*2000	0~10	Ventilated	4	Copeland	Remote
NW-HG15YMF	1500*1000*2000	0~10	Ventilated	4	Copeland	Remote
NW-HG20YMF	2000*1000*2000	0~10	Ventilated	4	Copeland	Remote
NW-HG25YMF	2500*1000*2000	0~10	Ventilated	4	Copeland	Remote
NW-HG30YMF	3000*1000*2000	0~10	Ventilated	4	Copeland	Remote



# Multideck Display Fridge

- Semi Cabinet

## Features

- Refrigerant: R22 / R404a
- Panasonic / Copeland compressor
- Ventilated cooling system
- Double layer tempered glass
- Digital controller
- Adjustable Shelves with price tag bar
- Copper evaporator
- LED light for every shelf
- Drain water box
- Stainless steel inner

SBG Series(Aluminum Frame)



PBG Series (Full Glass Without Frame)



SBG-AF Remoted Model



PBG-AF Remoted Model





# • Product Parameters

Model No	Product Size(mm)	Temp. Range(°C)	Cooling System	Shelf	Compressor	Remarks
NW-SBG/PBG15A	1500*850*1650	3~8	Ventilated	3	Panasonic	Plug-in
NW-SBG/PBG20A	2000*850*1650	3~8	Ventilated	3	Panasonic	Plug-in
NW-SBG/PBG25A	2500*850*1650	3~8	Ventilated	3	Panasonic	Plug-in
NW-SBG/PBG30A	3000*850*1650	3~8	Ventilated	3	Panasonic	Plug-in
NW-SBG/PBG15AF	1500*1000*1650	3~8	Ventilated	3	Copeland	Remote
NW-SBG/PBG20AF	2000*1000*1650	3~8	Ventilated	3	Copeland	Remote
NW-SBG/PBG25AF	2500*1000*1650	3~8	Ventilated	3	Copeland	Remote
NW-SBG/PBG30AF	3000*1000*1650	3~8	Ventilated	3	Copeland	Remote



# Mini Ring Cabinet

· Details Presentation

NW-SDG12/15D



NW-SDG20/25/30



NW-SDG12/15DF



NW-SDG20/25/30F





# • Product Parameters

Model No	Product Size(mm)	Temp. Range(°C)	Cooling System	Voltage	Refrigeration	Remarks
NW-SDG12D	1200*1200*1500	3~8	Ventilated	220V/50HZ	R404a	Plug-in
NW-SDG15D	1500*1500*1500	3~8	Ventilated	220V/50HZ	R404a	Plug-in
NW-SDG15R(Half)	1500*600/750*1500	3~8	Ventilated	220V/50HZ	R404a	Plug-in
NW-SDG20	1930*1500*1500	3~8	Ventilated	220V/50HZ	R404a	Plug-in
NW-SDG25	2430*1500*1500	3~8	Ventilated	220V/50HZ	R404a	Plug-in
NW-SDG30	2930*1500*1500	3~8	Ventilated	220V/50HZ	R404a	Plug-in
NW-SDG12DF	1200*1200*1500	3~8	Ventilated	220V/50HZ	R404a	Remote
NW-SDG15DF	1500*1500*1500	3~8	Ventilated	220V/50HZ	R404a	Remote
NW-SDG15RF(Half)	1500*600/750*1500	3~8	Ventilated	220V/50HZ	R404a	Remote
NW-SDG20F	1930*850*1500	3~8	Ventilated	220V/50HZ	R404a	Remote
NW-SDG25F	2430*850*1500	3~8	Ventilated	220V/50HZ	R404a	Remote
NW-SDG30F	2930*850*1500	3~8	Ventilated	220V/50HZ	R404a	Remote



# Dual-Temp Multi-Deck Cabinet

## Features

- Automatic defrost
- Automatic evaporation of defrosting water
- Digital thermostat
- Inside LED lamp
- Good display effect
- Suspension structure to save space
- Adjustable shelves

NW-ZHB15/20



Remote Model (Customized)



# • Product Parameters

Model No	Product Size(mm)	Temp. Range(°C)	Cooling System	Voltage	Compressor	Remarks
NW-ZHB15	1500*1000*2000	0~10/-18 ~ -22	Ventilated	220V/50HZ	Panasonic	Plug-in
NW-ZHB20	2000*1000*2000	0~10/-18 ~ -22	Ventilated	220V/50HZ	Panasonic	Plug-in
NW-ZHB25	2500*1000*2000	0~10/-18 ~ -22	Ventilated	220V/50HZ	Panasonic	Plug-in
NW-ZHB30	3000*1000*2000	0~10/-18 ~ -22	Ventilated	220V/50HZ	Panasonic	Plug-in
NW-ZHB15Q	1500*1000*2000	0~10/-18 ~ -22	Ventilated	220V/50HZ	Panasonic	Plug-in
NW-ZHB20Q	2000*1000*2000	0~10/-18 ~ -22	Ventilated	220V/50HZ	Panasonic	Plug-in
NW-ZHB25Q	2500*1000*2000	0~10/-18 ~ -22	Ventilated	220V/50HZ	Panasonic	Plug-in
NW-ZHB30Q	3000*1000*2000	0~10/-18 ~ -22	Ventilated	220V/50HZ	Panasonic	Plug-in
NW-ZBH20F	2000*1000*2000	0~10/-18 ~ -22	Ventilated	220V/380V/50HZ	Copeland	Remote
NW-ZBH25F	2500*1000*2000	0~10/-18 ~ -22	Ventilated	220V/380V/50HZ	Copeland	Remote
NW-ZBH30F	3000*1000*2000	0~10/-18 ~ -22	Ventilated	220V/380V/50HZ	Copeland	Remote



# Deli Display Fridge

- Arc Glass (Plug-In & Remote)

## Features

- For meat refrigeration and display
- Optional built-in remote cooling function
- Fully automatic defrost function to save energy
- Steel plate exterior with galvanized finish
- Black, gray, white, green, and gray are available
- Stainless steel interior and LED luminated
- Side galss are tempered type
- Optional back-up storage cabinet
- Smart controller and digital display screen
- With a clear curtain and great thermal insulation
- Copper tube evaporator & Fan assisted condenser

## Details Presentation

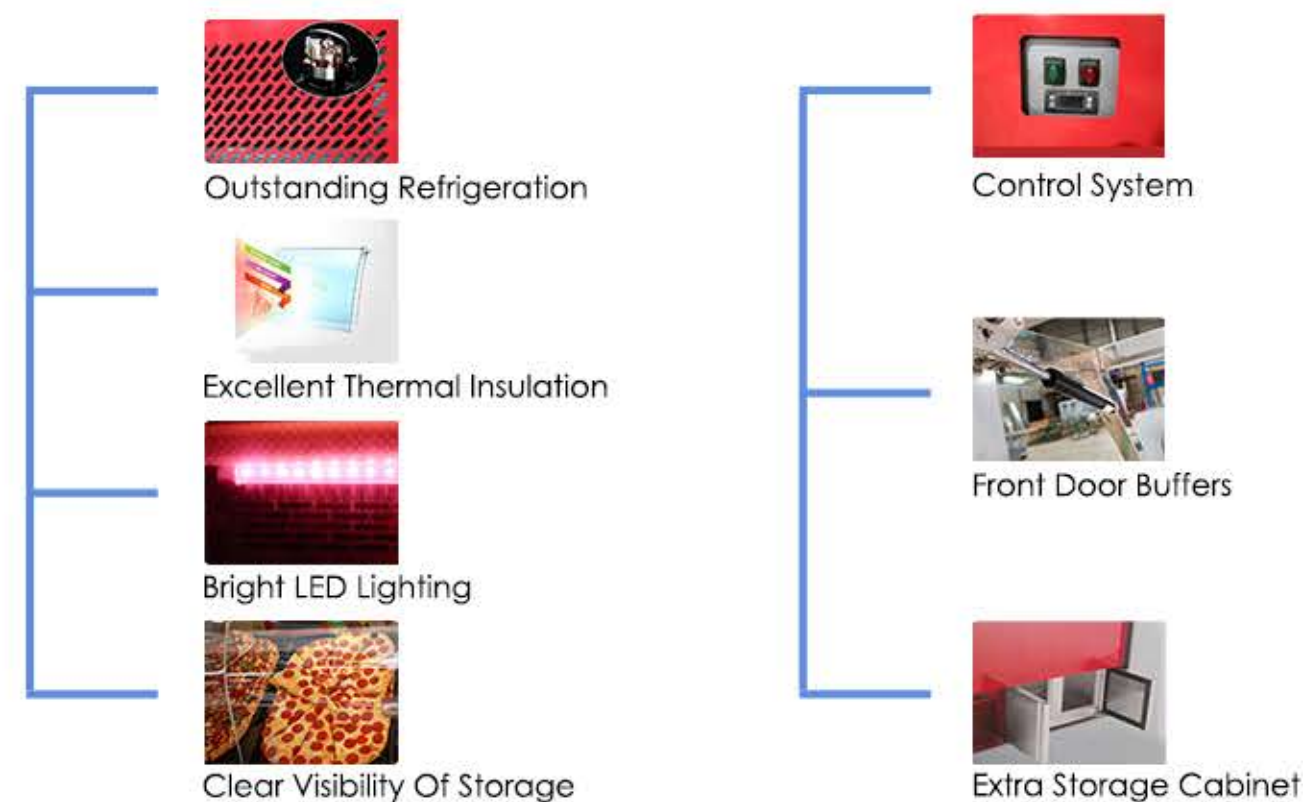

NW-SG-15A



NW-SG15AK (Front Open Door)



NW-SG15AY (Sliding Door)



NW-SG15AKF (Remoted Model)



Model No	Product Size(mm)	Temp. Range(°C)	Cooling System	Compressor	Remarks
NW-SG12A/AK/AY	1200*1080*1200	0~-8/-15 ~ -18	Ventilated	Panasonic	Plug-in
NW-SG15A/AK/AY	1500*1080*1200	0~-8/-15 ~ -18	Ventilated	Panasonic	Plug-in
NW-SG20A/AK/AY	2000*1080*1200	0~-8/-15 ~ -18	Ventilated	Panasonic	Plug-in
NW-SG25A/AK/AY	2500*1080*1200	0~-8/-15 ~ -18	Ventilated	Panasonic	Plug-in
NW-SG30A/AK/AY	3000*1080*1200	0~-8/-15 ~ -18	Ventilated	Panasonic	Plug-in
NW-SG12AF/AKF/AYF	1200*1080*1200	0~-8/-15 ~ -18	Ventilated	/	Remote
NW-SG15AF/AKF/AYF	1500*1080*1200	0~-8/-15 ~ -18	Ventilated	/	Remote
NW-SG20AF/AKF/AYF	2000*1080*1200	0~-8/-15 ~ -18	Ventilated	/	Remote
NW-SG25AF/AKF/AYF	2500*1080*1200	0~-8/-15 ~ -18	Ventilated	/	Remote
NW-SG30AF/AKF/AYF	3000*1080*1200	0~-8/-15 ~ -18	Ventilated	/	Remote



# Deli Display Fridge

- Right Angle Glass (Plug-In & Remote)

## Features

- The appearance looks nice and elegant, the display effect is excellent
- R404a refrigerant
- Off-cycle defrost, reduces the energy consumption
- The product uses high efficient evaporator, it increases the heat exchange rate, the refrigeration power is large
- There is a solenoid valve for each cabinet. We put a filter in front of the solenoid valve to reduce the difficulty and period of installation, limit the risk of dirt blockage
- Optional high efficiency fan can be selected according to customers' requirement
- The glass lifting structure se damping air pump spring, glass can be stopped at any angle. It's a convenient design for retuel and other dally work

NW-BSS Series

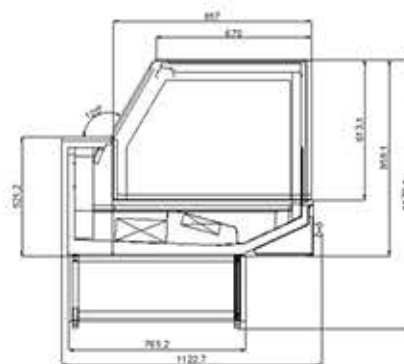

NW-CSS Series

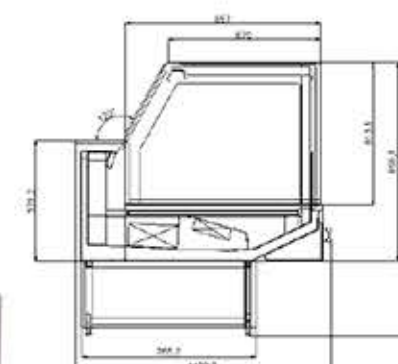

# • Product Parameters

Model No	Product Size(mm)	Temp. Range(°C)	Cooling System	Regrigerant	Compressor	Remarks
NW-BSS2011SGA	1875*1103*1145	-1~5	Ventilated	R404a	Secop	Plug-in
NW-BSS2511SGA	2500*1103*1145	-1~5	Ventilated	R404a	Secop	Plug-in
NW-BSS3811SGA	3750*1103*1600	-1~5	Ventilated	R404a	Secop	Plug-in
NW-CSS-2011SGA	1875*1103*1145	-1~5	Ventilated	/	/	Remote
NW-CSS2511SGA	2500*1103*1145	-1~5	Ventilated	/	/	Remote
NW-CSS3811SGA	3750*1103*1600	-1~5	Ventilated	/	/	Remote



# Meat Display Fridge

## Features

- For meat refrigeration and display
- Optional built-in remote cooling function
- Fully automatic defrost function to save energy
- Black, gray, white, green, and gray are available
- Stainless steel interior and LED luminated
- Side glass are tempered type
- Optional back-up storage cabinet
- Smart controller and digital display screen
- With a clear curtain and great thermal insulation
- Copper tube evaporator & Fan assisted condenser

## Details Presentation

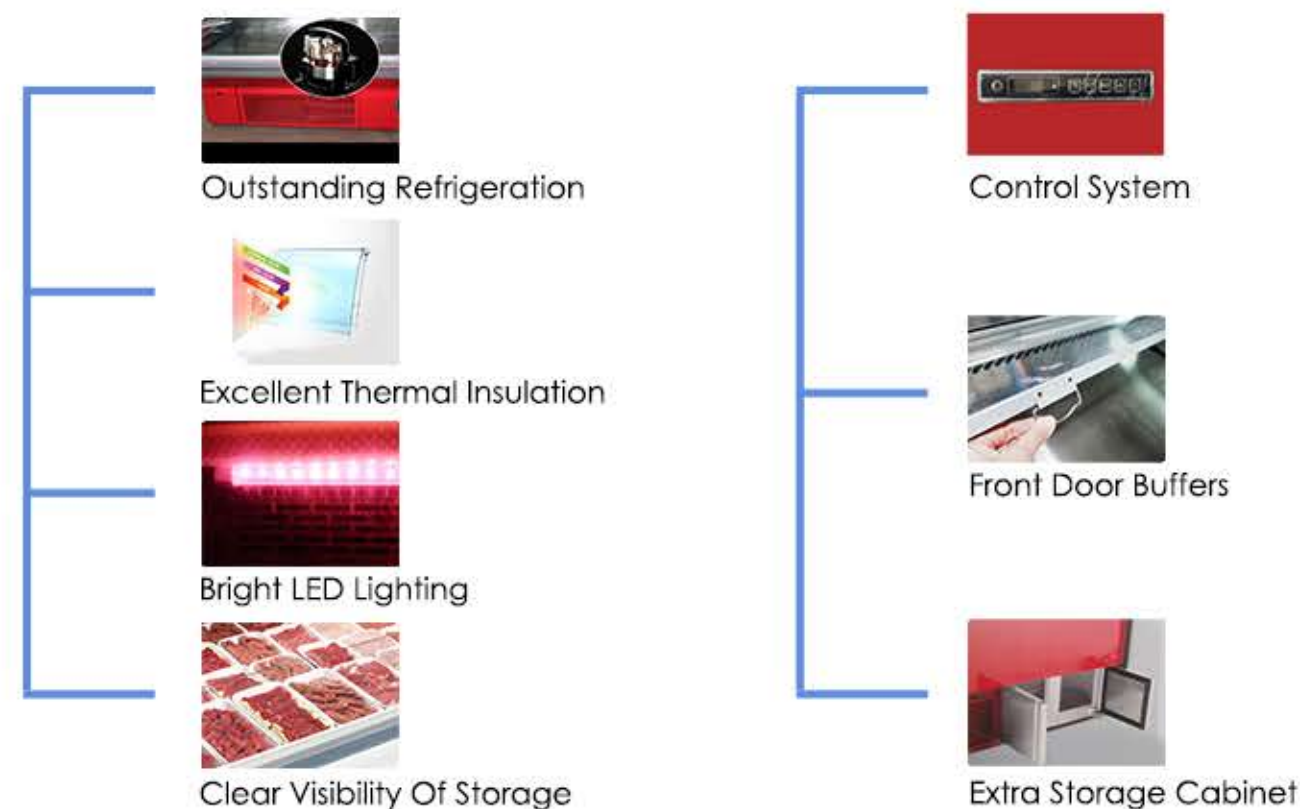

NW RG-15AG



NW-RG15A



NW-RG20AF



Model No	Product Size(mm)	Temp. Range(°C)	Cooling System	Refrigerant	Compressor	Remarks
NW-RG15A/AG	1050*1180*920	-2~8	Ventilated	R22	Panasonic	Plug-in
NW-RG20A/AG	2000*1180*920	-2~8	Ventilated	R22	Panasonic	Plug-in
NW-RG25A/AG	2500*1180*920	-2~8	Ventilated	R22	Panasonic	Plug-in
NW-RG30A/AG	3000*1180*920	-2~8	Ventilated	R22	Panasonic	Plug-in
NW-RG20AF	1050*1180*920	-2~8	Ventilated	/	/	Remote
NW-RG25AF	2000*1180*920	-2~8	Ventilated	/	/	Remote
NW-RG30AF	2500*1180*920	-2~8	Ventilated	/	/	Remote



# Stainless Steel Fish Counter

## Features

- Interior and exterior stainless steel AISI201
- Digital thermostat
- Adjustable feet or caster wheels selectable
- Copper evaporator

NW-ZTB20



NW-ZTB20A



# • Product Parameters

Model No	Product Size(mm)	Temp. Range(°C)	Cooling System	Refrigerant	Compressor	Remarks
NW-ZTB20	2000*900*800	0~10	Static	R404a	Scope	Plug-in
NW-ZTB25	2500*900*800	0~10	Static	R404a	Scope	Plug-in
NW-ZTB20A	2000*900*900	0~10	Ventilated	R22	Panasonic	Plug-in
NW-ZTB25A	2500*900*900	0~10	Ventilated	R22	Panasonic	Plug-in



# Combined Island Freezer

## Features

- Secop compressor
- Low-E glass door
- Auto-defrost
- Self-evaporation water tray
- Energy Saving
- Adjustable Shelf
- Led Light

## Details Presentation



Outstanding Refrigeration



Excellent Thermal Insulation



Crystal Visibility



Bright LED Lighting



Smart Control System



Durable Baskets



Model No	Product Size(mm)	Temp. Range(°C)	Cooling System	Refrigerant	Compressor	Remarks
NW-WD18D (End side)	1850x850x870	-18 ~ -22	Static	R290	Danfoss	Plug-in
NW-WD145	1450x850x870	-18 ~ -22	Static	R290	Danfoss	Plug-in
NW-WD2100	2100x850x870	-18 ~ -22	Static	R290	Danfoss	Plug-in
NW-WD2500	2500x850x870	-18 ~ -22	Static	R290	Danfoss	Plug-in



# Island Display Freezer

## Features

- Fan cooling system & auto defrost
- For bulk frozen food storage and display
- Temperature range between -18 ~ -22°C
- Compatible with R404a refrigerant
- Smart control system & remote monitor
- digital temperature display screen
- Inverter compressor
- lminated with LED lighting
- High-performance and energy saving
- Premium stainless steel exterior and interior

## Details Presentation



Outstanding Refrigeration



Excellent Thermal Insulation



Crystal Clear Visibility



Bright LED Lighting



Control System



Durable Baskets

NW-DG15



NW-DG20F



Model No	Product Size(mm)	Temp. Range(°C)	Cooling System	Refrigerant	Compressor	Remarks
NW-DG15	1500*1080*1020	-18 ~ -22	Ventilated	R404a	Secop	Plug-in
NW-DG20	2000*1080*1020	-18 ~ -22	Ventilated	R404a	Secop	Plug-in
NW-DG25	2500*1080*1020	-18 ~ -22	Ventilated	R404a	Secop	Plug-in
NW-DG30	3000*1080*1020	-18 ~ -22	Ventilated	R404a	Secop	Plug-in
NW-DG20F	1850*1080*1020	-18 ~ -22	Ventilated	R404a	Copeland	Remote
NW-DG25F	2350*1080*1020	-18 ~ -22	Ventilated	R404a	Copeland	Remote
NW-DG30F	2850*1080*1020	-18 ~ -22	Ventilated	R404a	Copeland	Remote



# Twins Island Display Freezer

## Features

- Fan cooling system & auto defrost
- For bulk frozen food storage and display
- Temperature range between -18 ~ -22°C
- Compatible with R404a refrigerant
- Smart control system & remote monitor
- digital temperature display screen
- Inverter compressor
- lminated with LED lighting
- High-performance and energy saving
- Premium stainless steel exterior and interior

## Details Presentation



Outstanding Refrigeration



Excellent Thermal Insulation



Crystal Clear Visibility



Bright LED Lighting



Control System



Durable Baskets

NW-DG20S



NW-DG20SF



Model No	Product Size(mm)	Temp. Range(°C)	Cooling System	Refrigerant	Compressor	Remarks
NW-DG20S	2000*1680*1050	-18 ~ -22	Ventilated	R404a	Secop	Plug-in
NW-DG25S	2500*1680*1050	-18 ~ -22	Ventilated	R404a	Secop	Plug-in
NW-DG30S	3000*1680*1050	-18 ~ -22	Ventilated	R404a	Secop	Plug-in
NW-DG20SF	1850*1800*1050	-18 ~ -22	Ventilated	R404a	Copeland	Remote
NW-DG25SF	2350*1800*1050	-18 ~ -22	Ventilated	R404a	Copeland	Remote
NW-DG30SF	2850*1800*1050	-18 ~ -22	Ventilated	R404a	Copeland	Remote



# Display Fridge & Freezer with Storage Room

## Features

- Glass door with heater, automatic defrost and crystal clear see-through
- Ball bearing slide design allows drinks feed in smoothly
- Automatic temperature control and defrost system with built-in micro-computer
- Stuffed with overall high density heat isolation materials, well preserved cold vibe
- Sturdy aluminum alloy frame structure, easy for cleaning but no rust
- Air cooling achieves fast and smooth cold effect

NW-LGH Series >>>



# • Product Parameters

Model No	Product Size(mm)	Temp. Range(°C)	Cooling System	Compressor	Remarks
NW-LGH3	2210*1800*2100	0~10/-18 ~ -22	Ventilated	Copeland	Remote
NW-LGH4	2910*1800*2100	0~10/-18 ~ -22	Ventilated	Copeland	Remote
NW-LGH5	3610*1800*2100	0~10/-18 ~ -22	Ventilated	Copeland	Remote
NW-LGH6	4310*1800*2100	0~10/-18 ~ -22	Ventilated	Copeland	Remote
NW-LGH7	5010*1800*2100	0~10/-18 ~ -22	Ventilated	Copeland	Remote
NW-LGH8	5710*1800*2100	0~10/-18 ~ -22	Ventilated	Copeland	Remote
NW-LGH9	6410*1800*2100	0~10/-18 ~ -22	Ventilated	Copeland	Remote
NW-LGH10	7110*1800*2100	0~10/-18 ~ -22	Ventilated	Copeland	Remote



# Supermarket Series



Nenwell Refrigeration Technology Co., Ltd.  
Foshan Nenwell Import & Export Trading Co., Ltd.

Total Solution of Commercial Refrigerators Tel: 0086-757-85856069 Web: <http://www.nenwell.com/>  
Address: Rm 601, Bld# 5A Tianan Mansion, Jianping Rd, Guicheng, Nanhai, Foshan, Guangdong, China

